

CR2016

Model	CR2016	
System	Manganese dioxide–Li/Organic Electrolyte	
Nominal Voltage (V)	3	
Nominal Capacity (mAh)*	90	
Nominal Discharge Current (mA)	0.1	
Temperature Ranges (deg. C)	min.	max.
Operating	-20	+85
Weight (g)**	1.9	
Dimensions (mm)**		
Diameter	20.0	
Height	1.6	
Negative Cap Diameter	15.8	
UL Recognition	MH12568 (N)	

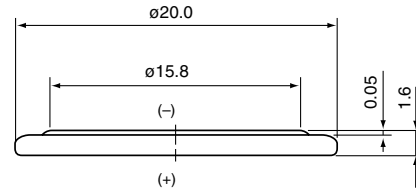

Available Terminals and Wire Connectors

None, bulk only.

Characteristics

● Discharge Characteristics

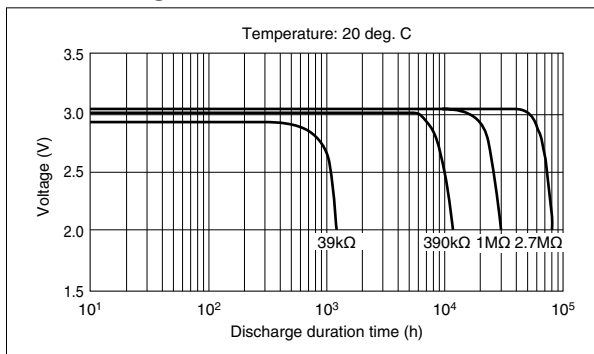

● Temperature Characteristics

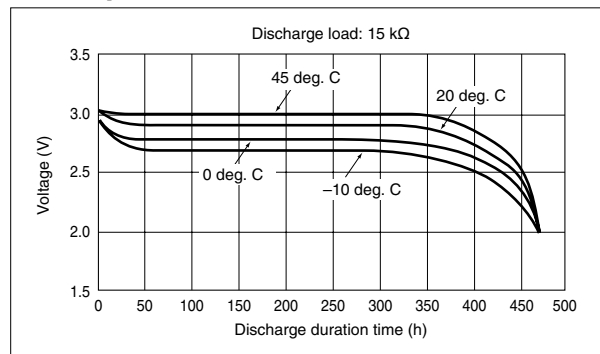

● Pulse Discharge Characteristics

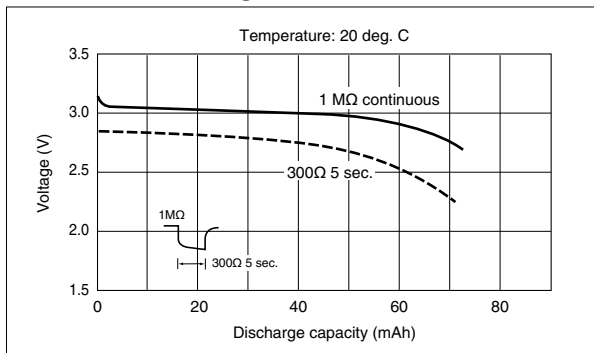

● Relationship between Discharge Current and Discharge Capacity

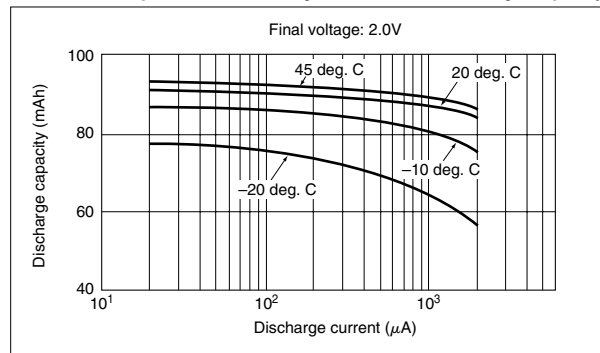

* Nominal capacity indicates duration until the voltage drops down to 2.0V when discharged at a nominal discharge current at 20 deg. C.

** Dimensions and weight are for the battery itself, but may vary depending on the shape of terminals or other factors.

CR Manganese Dioxide Lithium Batteries

Safety Instructions

This battery contains lithium, organic solvents, and other combustible materials. For this reason, improper handling of the battery could lead to distortion, leakage*, overheating, explosion, or fire, causing bodily injury or equipment trouble. Please observe the following instructions to prevent accidents. (* Leakage is defined as the unintentional escape of a liquid from a battery.)

WARNING Handling

Never swallow.

Always keep the battery out of the reach of infants and young children to prevent it from being swallowed. If swallowed, consult a physician immediately.

Never charge.

The battery is not designed to be charged by any other electrical source. Charging could generate gas and internal short-circuiting, leading to distortion, leakage, overheating, explosion, or fire.

Never heat.

Heating the battery to more than 100 deg. C could increase the internal pressure, causing distortion, leakage, overheating, explosion, or fire.

Never expose to open flames.

Exposing to flames could cause the lithium metal to melt, causing the battery to catch on fire and explode.

Never disassemble the battery.

Do not disassemble the battery, because the separator or gasket could be damaged, leading to distortion, leakage, overheating, explosion, or fire.

Never reverse the positive and negative terminals when mounting.

Improper mounting of the battery could lead to short-circuiting, charging or forced-discharging. This could cause distortion, leakage, overheating, explosion, or fire.

Never short-circuit the battery.

Do not allow the positive and negative terminals to short-circuit. Never carry or store the battery with metal objects such as a necklace or a hairpin. Otherwise, this could lead to distortion, leakage, overheating, explosion, or fire.

Never weld the terminals or weld a wire to the body of the battery directly.

The heat of welding or soldering could cause the lithium to melt, or cause damage to the insulating material in the battery. This could cause distortion, leakage, overheating, explosion, or fire. When soldering the battery directly to equipment, solder only the tabs or leads. Even then, the temperature of the soldering iron must be below 350 deg. C and the soldering time less than 5 seconds. Do not use a soldering bath, because the circuit board with battery attached could stop moving or the battery could drop into the bath. Moreover do not use excessive solder, because the solder could flow to unwanted portions of the board, leading to a short-circuit or charging of the battery.

Never use different batteries together.

Using different batteries together, i.e. different type or used and new or different manufacturer could cause distortion, leakage, overheating, explosion, or fire because of the differences in battery property. If using two or more batteries connected in series or in parallel even same batteries, please consult with Maxell before using.

Never allow liquid leaking from the battery to get in your eyes or mouth.

Because this liquid could cause serious damage, if it does come in contact with your eyes, flush them immediately with plenty of water and consult a physician. Likewise, if the liquid gets in your mouth, rinse immediately with plenty of water and consult a physician.

Keep a leaking battery away from fire.

If leakage is suspected or you detect a strong odor, keep the battery away from fire, because the leaked liquid could catch on fire.

Never touch the battery electrodes.

Do not allow the battery electrodes to come in contact with your skin or fingers. Otherwise, the moisture from your skin could cause a discharge of the battery, which could produce certain chemical substances causing you to receive a chemical burns.

WARNING Circuit Design for Back-up Use

This is a primary battery and cannot be charged. If used in memory or RTC back-up applications, be sure to use diodes to prevent charging from the main power source or other batteries, and protective resistance to regulate the current as shown in the figure below. Note that the points described below should be taken into careful consideration when selecting diodes and protective resistance.

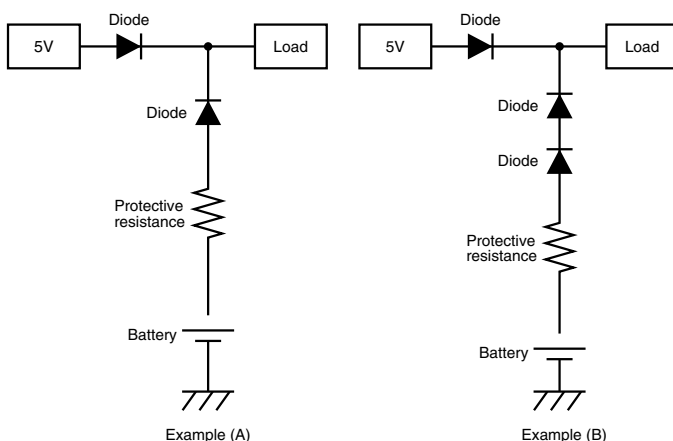

Supplied voltage to load.

Because a diode and a resistance generate the voltage drop on operating, please take into consideration these voltage drops for supplied voltage to load.

Using diodes to prevent charging

Please choose diodes with leak current as small as possible. Please keep the charged capacity due to leak current to within 1% of nominal capacity.

Using and setting protective resistance

Protective resistance is used to prevent the battery from being charged by large surges of current during diode failure. Please set the resistance so that the maximum current shown in the right table is not exceeded. For example, say a CR2032 battery is used in sample circuit (A) in combination with a main power source 5 volt. Since the permitted charge current is 10mA and this battery's voltage is 3V, let resistance be $R > = (5V - 3V) / 10mA = 0.2k \text{ ohm}$, meaning that at least 0.2k ohm is required.

Type	Maximum Current
CR2450	15mA
CR2430	15mA
CR2032H	10mA
CR2032	10mA
CR2025	10mA
CR2016	10mA
CR2012	10mA
CR1620	2.5mA
CR1616	2.5mA
CR1220	3.0mA
CR1216	2.5mA
CR1025	2.5mA

WARNING Disposal

The battery may be regulated by national or local regulation. Please follow the instructions of proper regulation. As electric capacity is left in a discarded battery and it comes into contact with other metals, it could lead to distortion, leakage, overheating, or explosion, so make sure to cover the (+) and (-) terminals with friction tape or some other insulator before disposal.

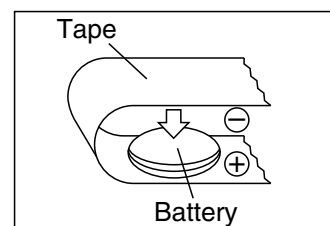

Example of vattery insulation

CAUTION Handling/Storage**Never expose the battery to ultrasonic sound.**

Exposing the battery to ultrasonic sound may cause short-circuiting because the inside material is broken into pieces, leading to distortion, leakage, overheating, explosion, or fire.

Never subject the battery to severe shock.

Dropping, throwing or stomping on the battery may cause distortion, leakage, overheating, explosion, or fire.

Never short-circuit the battery while installing into equipment.

Please be careful when installing the battery not to short-circuit it with metal portions of the equipment.

Use the correct battery suitable for the equipment.

The battery may not be suitable for the specific equipment due to the using conditions or type of equipment. Please select the suitable battery according to the handling instructions of the equipment.

Never use or leave the battery in a hot place such as under the direct rays of the sun or in a car in hot weather.

If you do, this may cause distortion, leakage, overheating, explosion, or fire.

Never allow the battery to come in contact with water.

If it does, this may cause the battery to rust or lead to distortion, leakage, overheating, explosion, or fire.

Never store the battery in a hot and highly humid environment.

Doing so may cause the performance of the battery to deteriorate. In certain environments, this may lead to distortion, leakage, overheating, explosion, or fire.

- Data and dimensions are just reference values. For further details, please contact us at your nearest Maxell office.
- Contents on this website are subject to change without notice.

* Nominal capacity indicates duration until the voltage drops down to 2.0V when discharged at a nominal discharge current at 20 deg. C.

** Dimensions and weight are for the battery itself, but may vary depending on the shape of terminals or other factors.