

maxell

# Lithium Manganese Dioxide Battery (Li/MnO<sub>2</sub>)

CR2450 / CR2430 / CR2032H / CR2032 / CR2025 / CR2016 /  
CR2012 / CR1620 / CR1616 / CR1220 / CR1216 / CR1025 /

With Terminals and Wire Connectors

(CR2450 / CR2032 / CR2025 / CR1616 / CR1220)

Heat Resistant Coin Type

CR2450HR / CR2450HR-Ex

CR17450 / CR17335

LITHIUM MANGANESE DIOXIDE BATTERY



## Safety Instructions

This battery contains lithium, organic solvents, and other combustible materials. For this reason, improper handling of the battery could lead to distortion, leakage\*, overheating, explosion, or fire, causing bodily injury or equipment trouble.

Please observe the following instructions to prevent accidents.

(\* Leakage is defined as the unintentional escape of a liquid from a battery.)

### Warnings Handling

#### Never swallow.

Always keep the battery out of the reach of infants and young children to prevent it from being swallowed. If swallowed, consult a physician immediately.

#### Never charge.

The battery is not designed to be charged by any other electrical source. Charging could generate gas and internal short-circuiting, leading to distortion, leakage, overheating, explosion, or fire.

#### Never heat.

Heating the battery to more than 100 deg. C\* could increase the internal pressure, causing distortion, leakage, overheating, explosion, or fire. (\* Consult Maxell regarding heat resistant coin type lithium manganese dioxide batteries.)

#### Never expose to open flames.

Exposing to flames could cause the lithium metal to melt, causing the battery to catch on fire and explode.

#### Never disassemble the battery.

Do not disassemble the battery, because the separator or gasket could be damaged, leading to distortion, leakage, overheating, explosion, or fire.

#### Never reverse the positive and negative terminals when mounting.

Improper mounting of the battery could lead to short-circuiting, charging or forced-discharging. This could cause distortion, leakage, overheating, explosion, or fire.

#### Never short-circuit the battery.

Do not allow the positive and negative terminals to short-circuit. Never carry or store the battery with metal objects such as a necklace or a hairpin. Do not take multiple batteries out of the package and pile or mix them when storing. Otherwise, this could lead to distortion, leakage, overheating, explosion, or fire.

#### Never weld the terminals or weld a wire to the body of the battery directly.

The heat of welding or soldering could cause the lithium to melt, or cause damage to the insulating material in the battery. This could cause distortion, leakage, overheating, explosion, or fire. When soldering the battery directly to equipment, solder only the tabs or leads. Even then, the temperature of the soldering iron must be below 350 deg. C and the soldering time less than 5 seconds. Do not use a soldering bath, because the circuit board with battery attached could stop moving or the battery could drop into the bath. Moreover do not use excessive solder, because the solder could flow to unwanted portions of the board, leading to a short-circuit or charging of the battery.

#### Never use different batteries together.

Using different batteries together, i.e. different type or used and new or different manufacturer could cause distortion, leakage, overheating, explosion, or fire because of the differences in battery property. If using two or more batteries connected in series or in parallel even same batteries, please consult with Maxell before using.

#### Never allow liquid leaking from the battery to get in your eyes or mouth.

Because this liquid could cause serious damage, if it does come in contact with your eyes, flush them immediately with plenty of water and consult a physician. Likewise, if the liquid gets in your mouth, rinse immediately with plenty of water and consult a physician.

#### Keep leaking batteries away from fire.

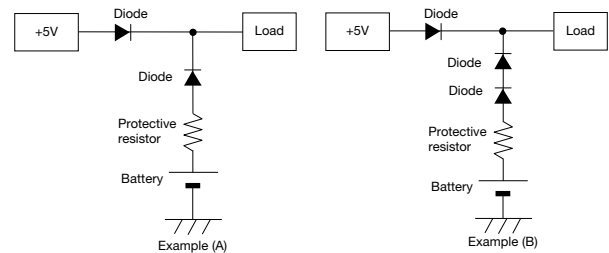
If leakage is suspected or you detect a strong odor, keep the battery away from fire, because the leaked liquid could catch on fire.

#### Never touch the battery electrodes.

Do not allow the battery electrodes to come in contact with your skin or fingers. Otherwise, the moisture from your skin could cause a discharge of the battery, which could produce certain chemical substances causing you to receive a chemical burns.

### Warnings Circuit Design for Back-up Use

This is a primary battery and cannot be charged. If used in memory or RTC back-up applications, be sure to use diodes to prevent charging from the main power source or other batteries, and a protective resistor to regulate the current as shown in the figure below. Note that the points described below should be taken into careful consideration when selecting diodes and protective resistors.



#### Supplied voltage to load

Because a diode and a resistor generate the voltage drop on operating, please take into consideration these voltage drops for supplied voltage to load.

#### Using diodes to prevent charging

Please choose diodes with leak current as small as possible. Please keep the charged capacity due to leak current to within 1% of nominal capacity.

#### Using and setting protective resistors

A protective resistor is used to prevent the battery from being charged by large surges of current during diode failure. Please set the resistor so that the maximum current shown in the right table is not exceeded. For example, say a CR2032 battery is used in sample circuit (A) in combination with a main power source 5 volt. Since the permitted charge current is 10mA and this battery's voltage is 3V, let the resistor be  $R \geq (5V-3V)/10mA=0.2k \text{ ohm}$ , meaning that at least 0.2k ohm is required.

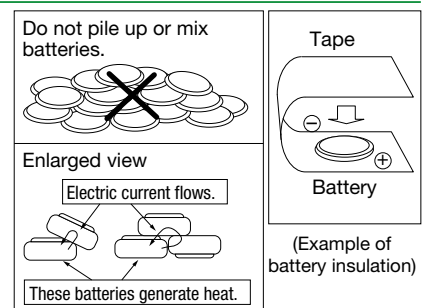
Type	Maximum Current
CR2450	15mA
CR2430	15mA
CR2032H	10mA
CR2032	10mA
CR2025	10mA
CR2016	10mA
CR2012	10mA
CR1620	4.0mA
CR1616	2.5mA
CR1220	3.0mA
CR1216	2.5mA
CR1025	2.5mA
CR2450HR	15mA
CR2450HR-Ex	15mA
CR17450	20mA
CR17335	20mA

### Warnings Disposal

The battery may be regulated by national or local regulation.

Please follow the instructions of proper regulation. As electric capacity is left in a discarded battery and it comes into contact with other metals, it could lead to

distortion, leakage, overheating, or explosion, so make sure to cover the (+) and (-) terminals with friction tape or some other insulator before disposal.



## **Caution** Handling/Storage

### ■ Never expose the battery to ultrasonic sound.

Exposing the battery to ultrasonic sound may cause short-circuiting because the inside material is broken into pieces, leading to distortion, leakage, overheating, explosion, or fire.

### ■ Never subject the battery to severe shock.

Dropping, throwing or stomping on the battery may cause distortion, leakage, overheating, explosion, or fire.

### ■ Never short-circuit the battery while installing into equipment.

Please be careful when installing the battery not to short-circuit it with metal portions of the equipment.

### ■ Use the correct battery suitable for the equipment.

The battery may not be suitable for the specific equipment due to the using conditions or type of equipment. Please select the suitable battery according to the handling instructions of the equipment.

### ■ Never use or leave the battery in a hot place such as under the direct rays of the sun or in a car in hot weather.

If you do, this may cause distortion, leakage, overheating, explosion, or fire.

### ■ Never allow the battery to come in contact with water.

If it does, this may cause the battery to rust or lead to distortion, leakage, overheating, explosion, or fire.

### ■ Never store the battery in a hot and highly humid environment.

Doing so may cause the performance of the battery to deteriorate. In certain environments, this may lead to distortion, leakage, overheating, explosion, or fire.

### ■ Keep contact pressure more than 2N.

The battery voltage may be lower than intended value because of poor contact condition, please keep contact pressure more than 2N for suitable contact resistance.

## Overview

The coin-type lithium manganese dioxide battery (CR battery) is a small, lightweight battery with an operating voltage of 3V and the ability to operate over a wide temperature range. It has a wide range of applications, both for powering devices such as wristwatches and electronic calculators and can be used in all types of electronic devices mainly as memory and RTC backup.

## Products

Model	CR2450	CR2430	CR2032H	CR2032	CR2025	CR2016	CR2012	CR1620	CR1616	CR1220	CR1216	CR1025
Nominal Voltage (V)	3	3	3	3	3	3	3	3	3	3	3	3
Nominal Capacity (mAh)**	610	290	240	220	170	90	50	80	55	36	25	30
Nominal Discharge Current (mA)	0.2	0.2	0.2	0.2	0.2	0.1	0.1	0.1	0.1	0.1	0.1	0.1
Operating Temperature Range (deg. C)***	-20 to +85											
Dimensions*	Diameter (mm)	24.5	24.5	20.0	20.0	20.0	20.0	16.0	16.0	12.5	12.5	10.0
	Height (mm)	5.0	3.0	3.2	3.2	2.5	1.6	1.2	2.0	1.6	2.0	1.6
Weight (g)*	6.6	4.6	3.0	3.0	2.5	1.7	1.4	1.3	1.1	0.8	0.6	0.6

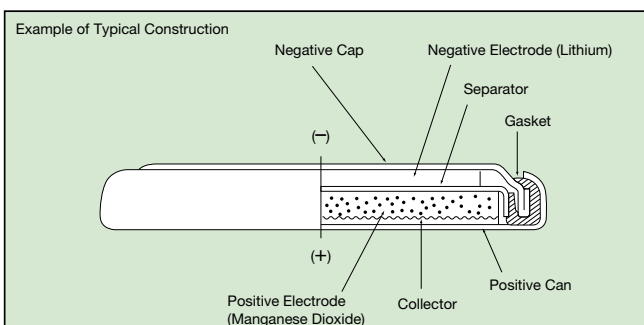
\* Dimensions and weight are for the battery itself, but may vary depending on terminal specifications and other factors.

\*\* Nominal capacity indicates duration until the voltage drops down to 2.0V when discharged at a nominal discharge current at 20 deg. C.

\*\*\*When using these batteries at temperatures outside the range of 0 to +40 deg. C, please consult Maxell in advance for conditions of use.

• Data and dimensions are just reference values. For further details, please contact your nearest Maxell dealer or distributor.

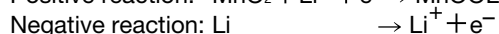
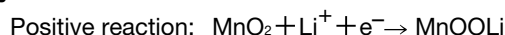
## Construction



## Principle and Reactions

The coin-type lithium manganese dioxide battery uses manganese dioxide ( $MnO_2$ ) as its positive active material, lithium (Li) as its negative active material, and an organic electrolyte.

### ■ Battery Reactions

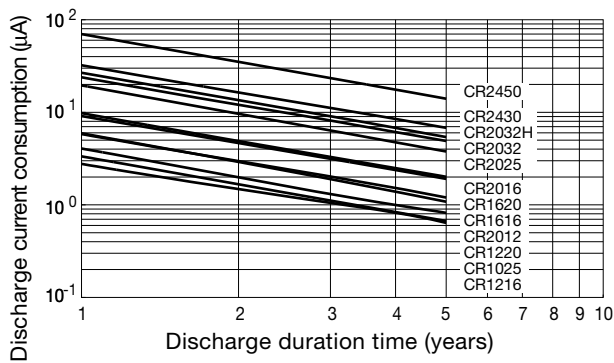


**Features**

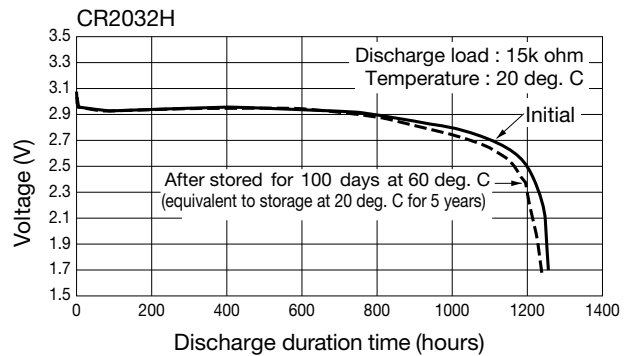
- **Optimum for Memory and RTC Backup (Fig. 1)**  
Displays long-term stable operating voltage at low load discharge.
- **High 3 volt energy density**  
High energy density. At 3 volts (nominal voltage), it has about twice the voltage of alkaline button batteries and silver oxide batteries.
- **Stable discharge characteristics through low internal resistance and high operating voltage**  
Employs highly conductive electrolyte, lowering internal resistance and providing stable operating voltage. This allows stable power to be obtained, with little change in

- operating voltage at room temperature as well as high and low temperatures.
- **Superior leakage resistance and excellent storage characteristics (Fig. 2)**  
Employs a leak-resistant organic electrolyte, giving it better leakage resistance than battery types using alkaline electrolytes. Furthermore, the high degree of seal of the seal structure and application of sealant keep self-discharge to about 1% per year.
- **Superior high rate discharge characteristics (Fig. 3)**

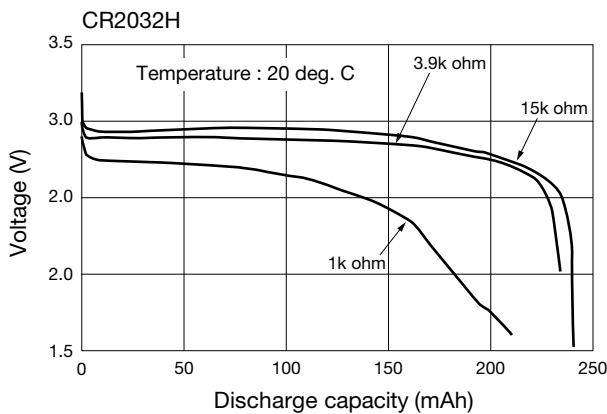
**Fig. 1 Relationship between Discharge Current Consumption and Duration Time**



**Fig. 2 Discharge Characteristics after Storage**



**Fig. 3 High Rate Discharge Characteristics**



**UL Recognized Components**

The coin-type lithium manganese dioxide battery is a UL (Underwriters Laboratories Inc.) recognized component.

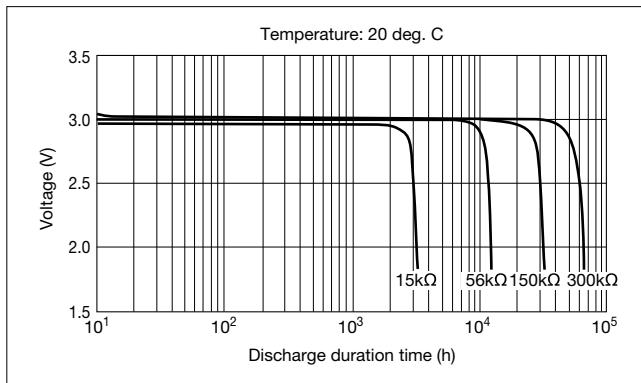
Recognized models:  
CR2450, CR2430, CR2032, CR2032H, CR2025, CR2016, CR2012, CR1620, CR1616, CR1220, CR1216, CR1025  
Certification Number: MH12568

**Applications**

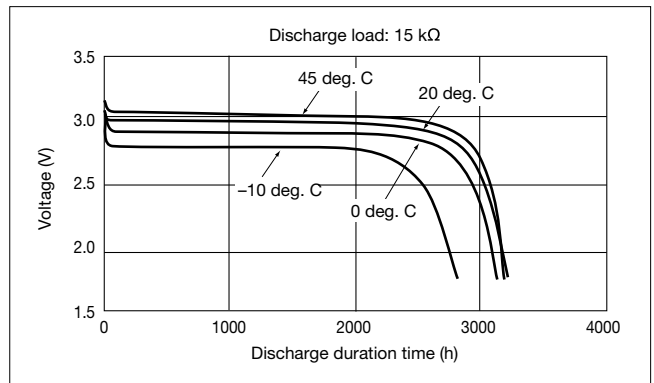
- OA Machines (Fax, Copiers, Printers)
- PDA's
- Camcorders
- Portable CD/MD Players
- Electronic Meters (Water, Gas, Electricity)
- Remote Controllers
- FA Instruments (Measuring Instruments, Onboard Microcomputers, Sensors)
- Notebook PCs
- Electronic Dictionaries
- Digital Still Cameras
- Watches
- Keyless Entry Systems
- Desktop PCs
- Calculators
- Film Cameras
- Medical Instruments, Cash Registers
- Portable Game Devices

## CR2450 (610mAh)

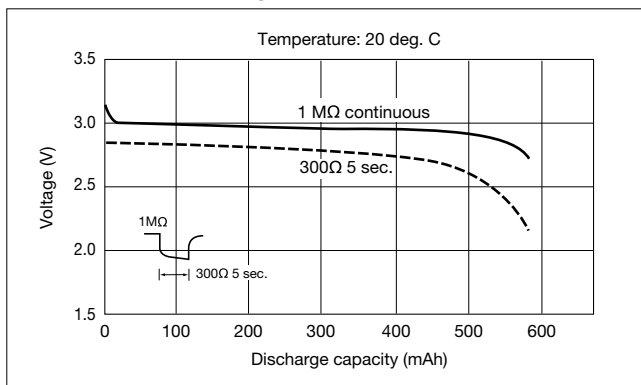
### Discharge Characteristics



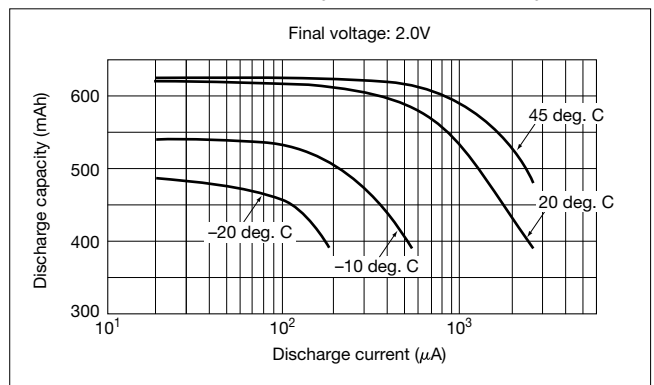
### Temperature Characteristics



### Pulse Discharge Characteristics

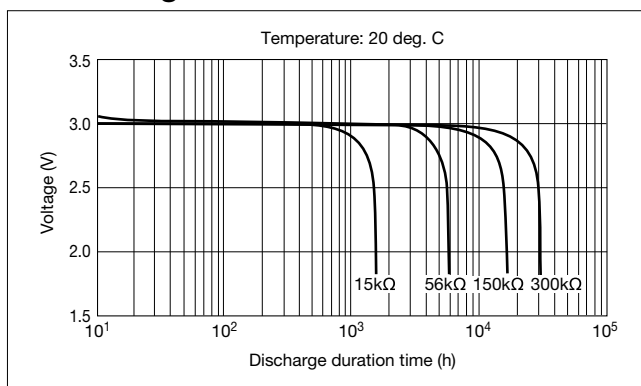


### Relationship between Discharge Current and Discharge Capacity

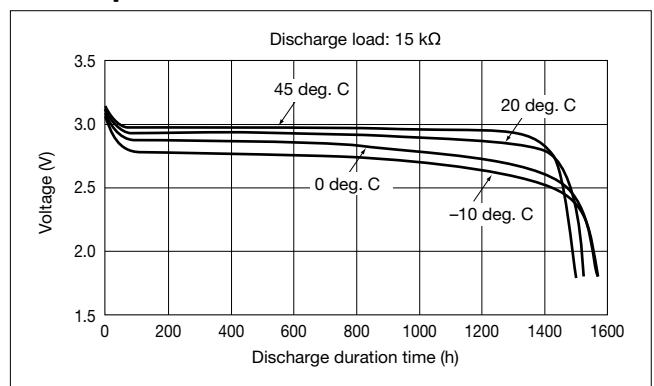


## CR2430 (290mAh)

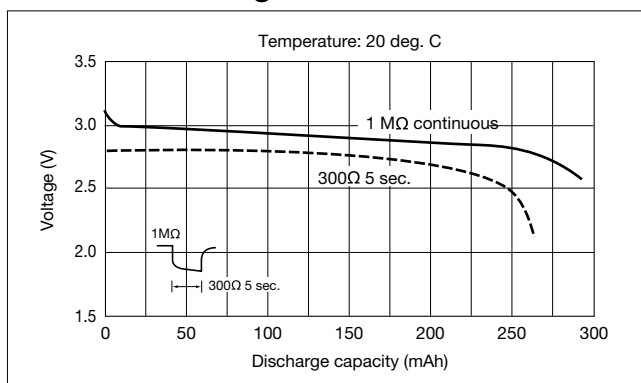
### Discharge Characteristics



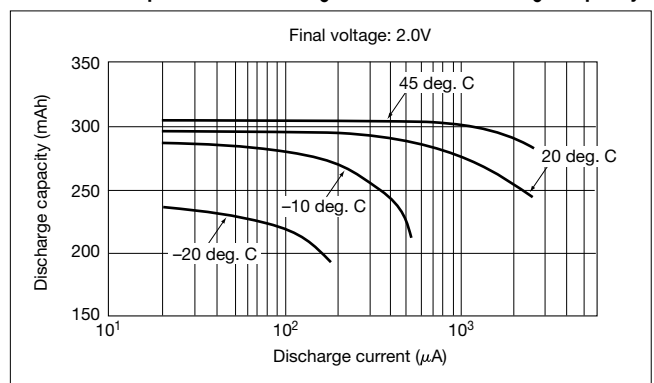
### Temperature Characteristics



### Pulse Discharge Characteristics

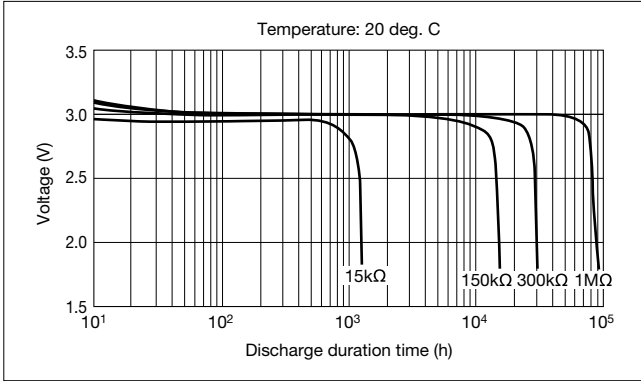


### Relationship between Discharge Current and Discharge Capacity

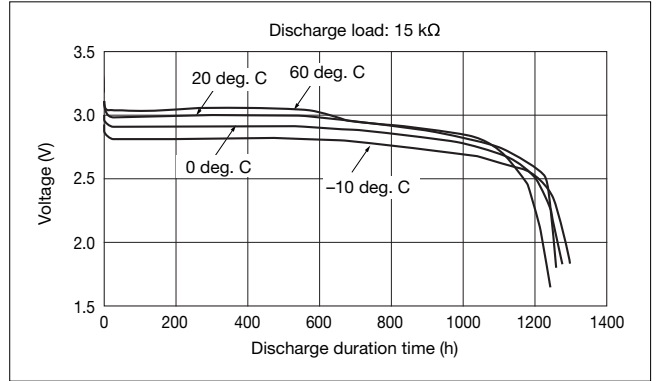


# CR2032H (240mAh)

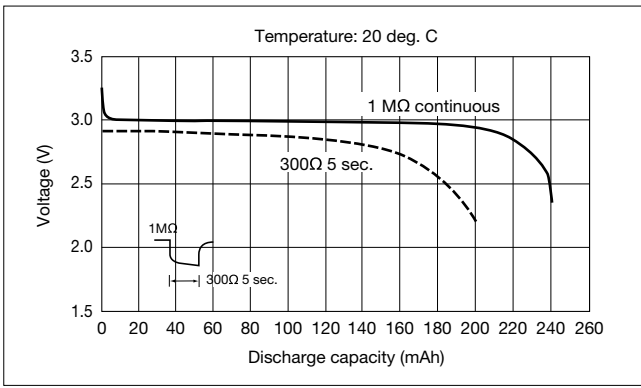
## Discharge Characteristics



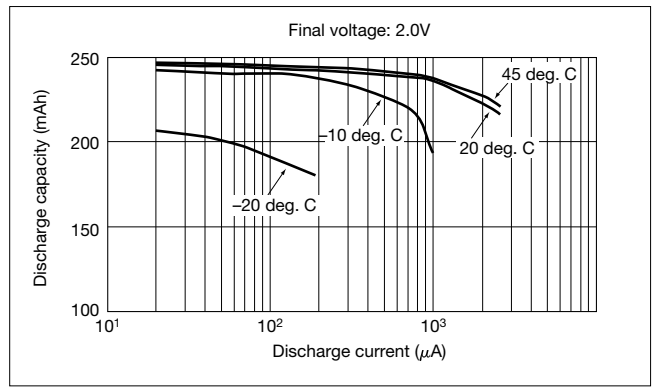
## Temperature Characteristics



## Pulse Discharge Characteristics

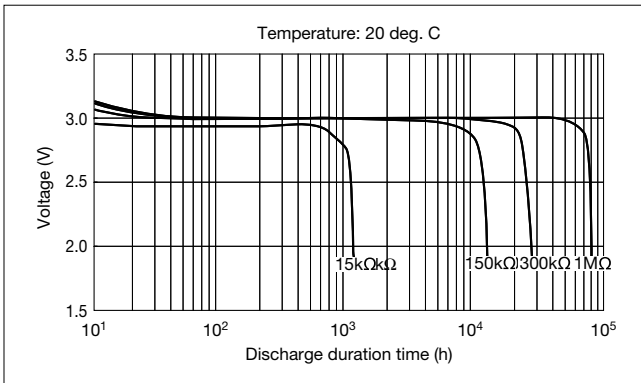


## Relationship between Discharge Current and Discharge Capacity

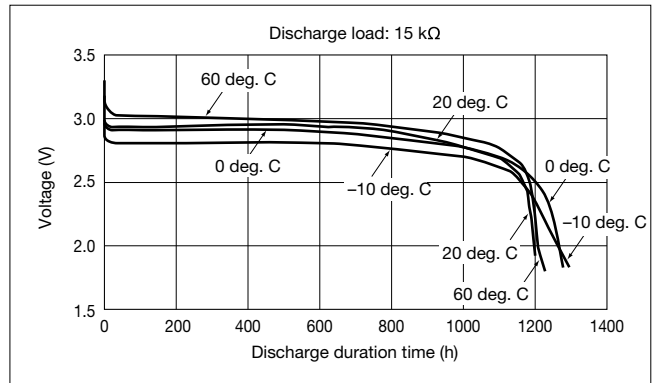


# CR2032 (220mAh)

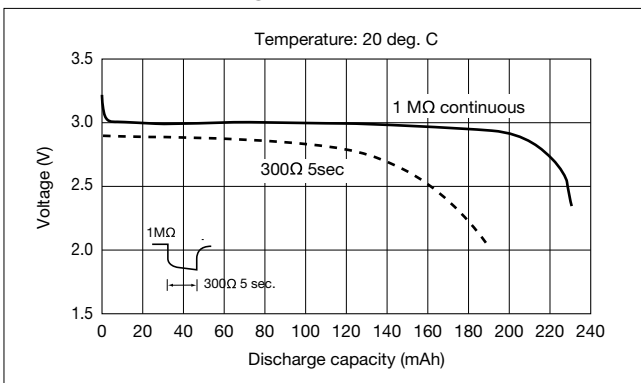
## Discharge Characteristics



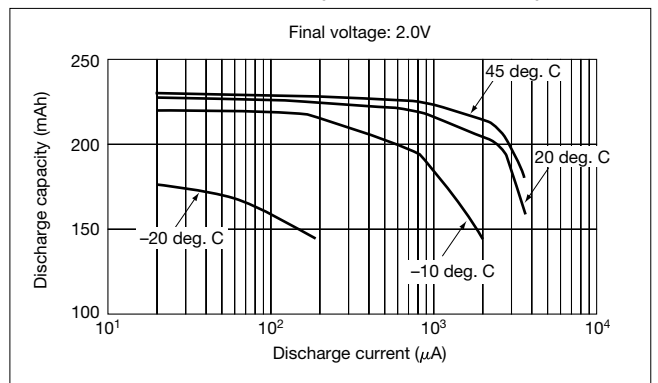
## Temperature Characteristics



## Pulse Discharge Characteristics

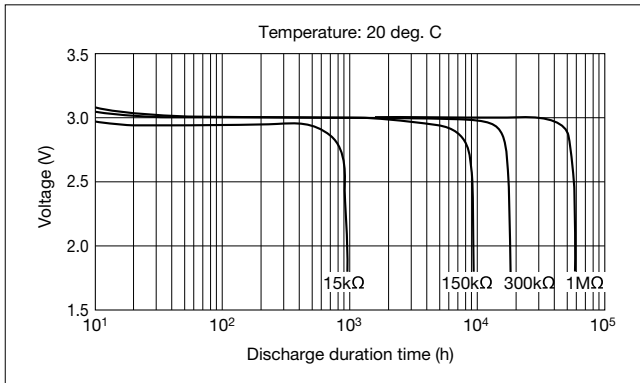


## Relationship between Discharge Current and Discharge Capacity

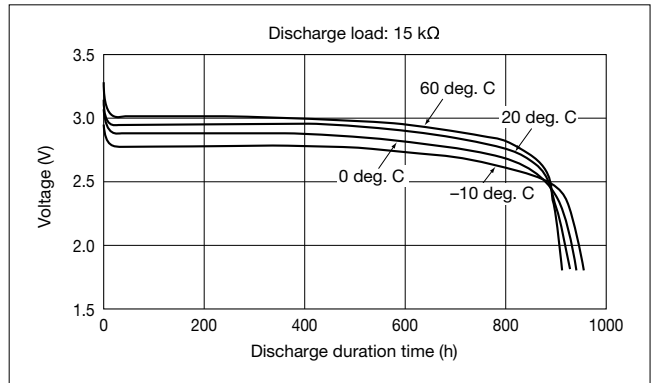


## CR2025 (170mAh)

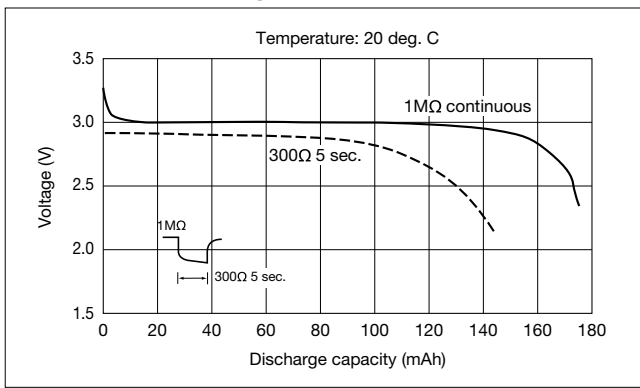
### Discharge Characteristics



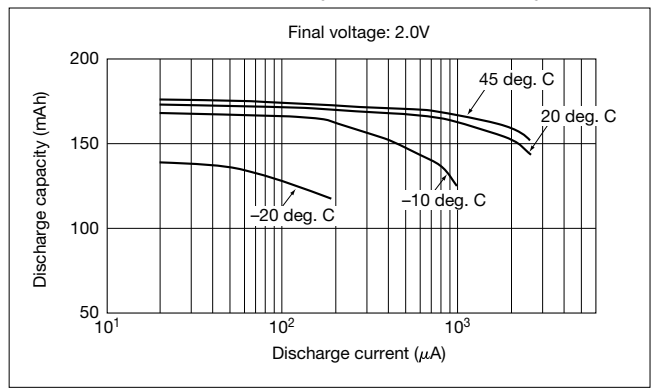
### Temperature Characteristics



### Pulse Discharge Characteristics

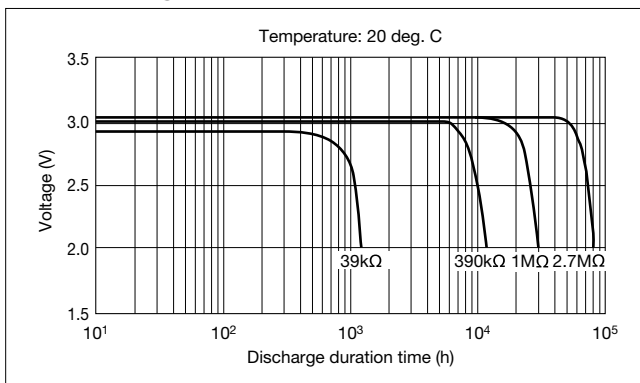


### Relationship between Discharge Current and Discharge Capacity

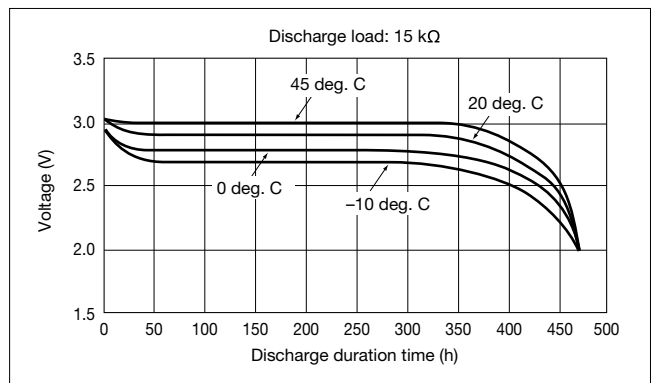


## CR2016 (90mAh)

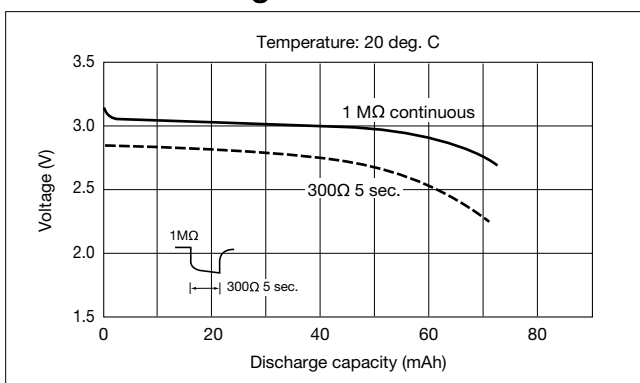
### Discharge Characteristics



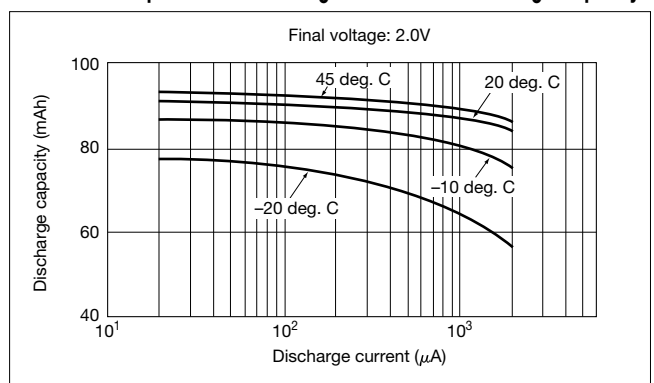
### Temperature Characteristics



### Pulse Discharge Characteristics

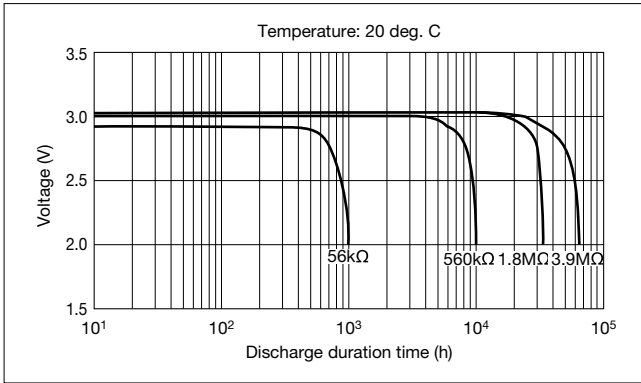


### Relationship between Discharge Current and Discharge Capacity

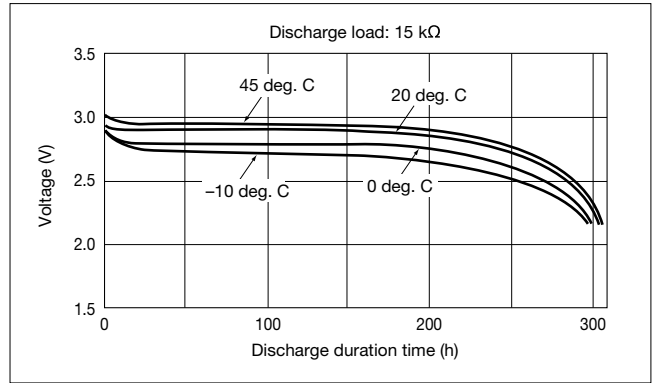


**CR2012** (50mAh)

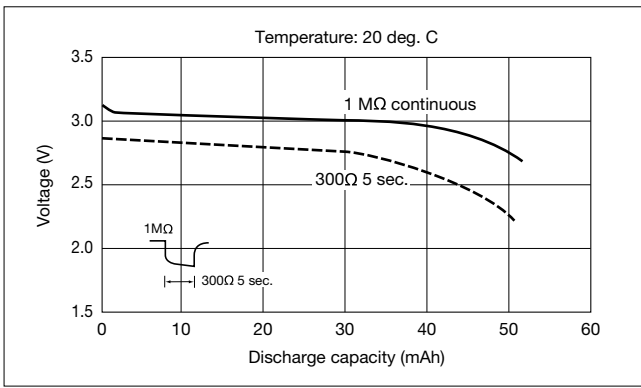
**Discharge Characteristics**



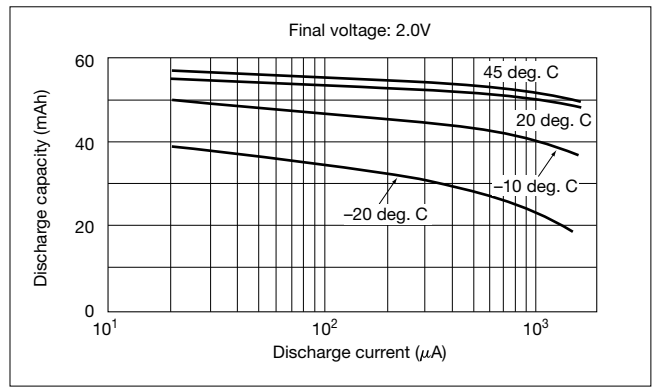
**Temperature Characteristics**



**Pulse Discharge Characteristics**

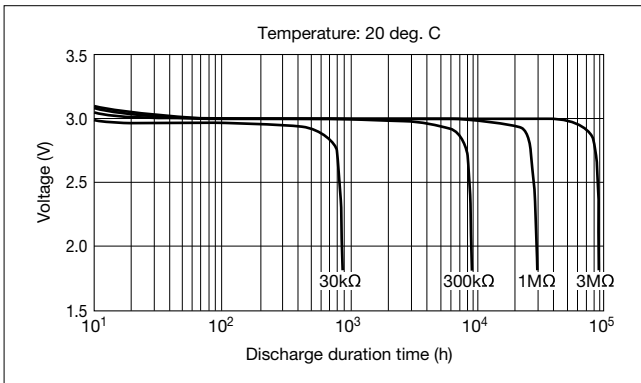


**Relationship between Discharge Current and Discharge Capacity**

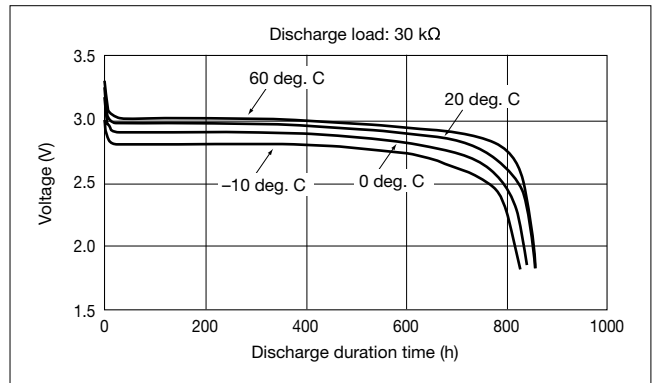


**CR1620** (80mAh)

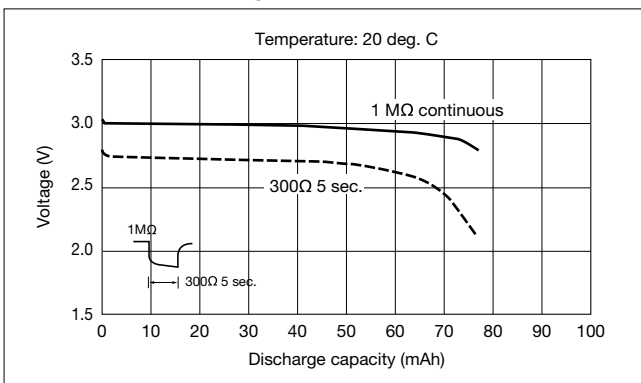
**Discharge Characteristics**



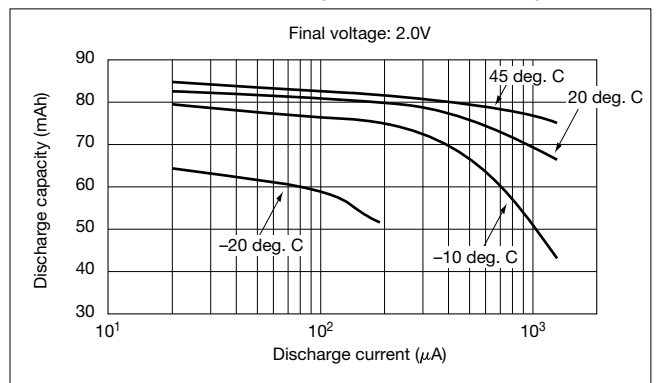
**Temperature Characteristics**



**Pulse Discharge Characteristics**



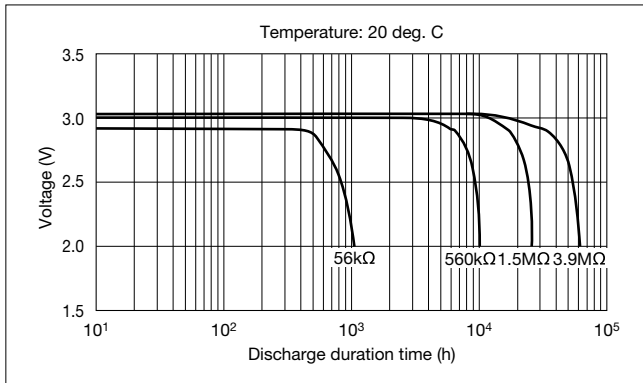
**Relationship between Discharge Current and Discharge Capacity**



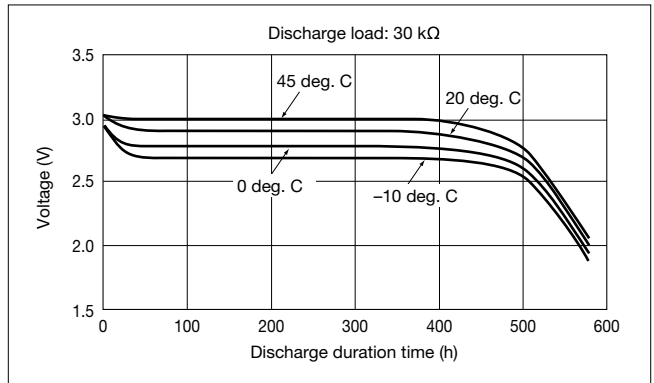


## CR1616 (55mAh)

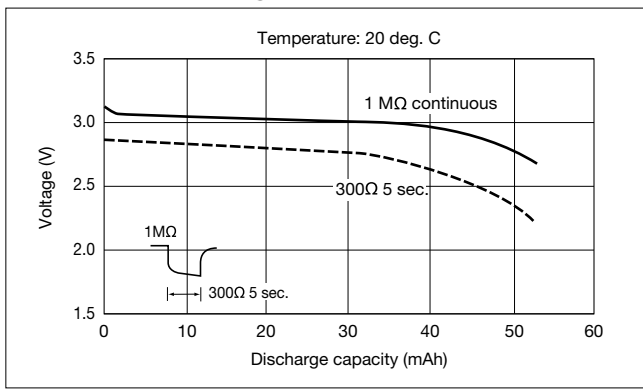
### Discharge Characteristics



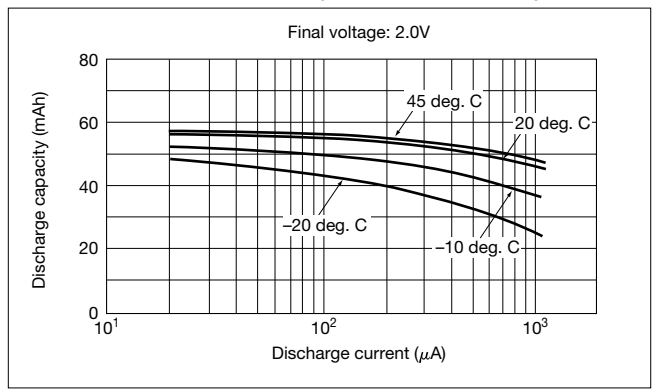
### Temperature Characteristics



### Pulse Discharge Characteristics

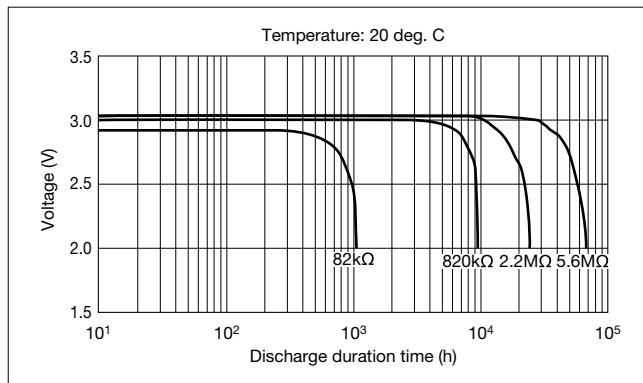


### Relationship between Discharge Current and Discharge Capacity

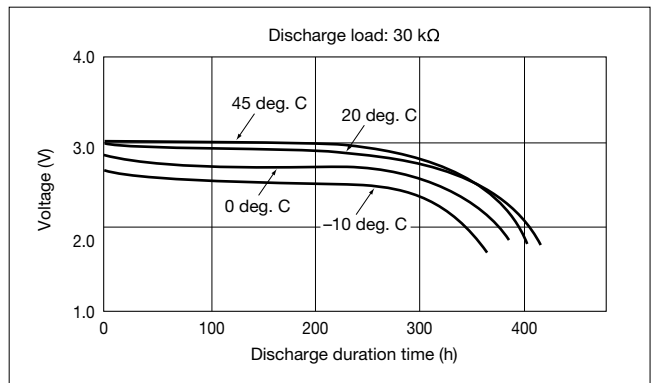


## CR1220 (36mAh)

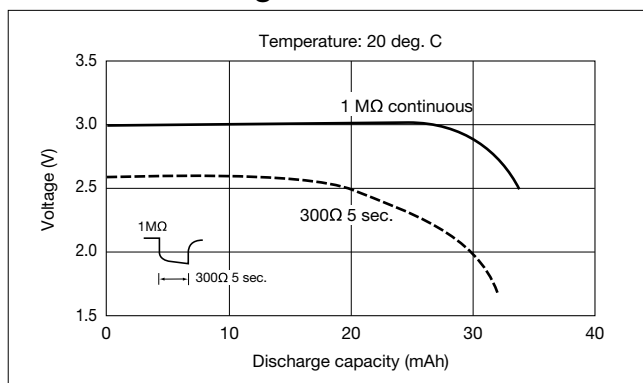
### Discharge Characteristics



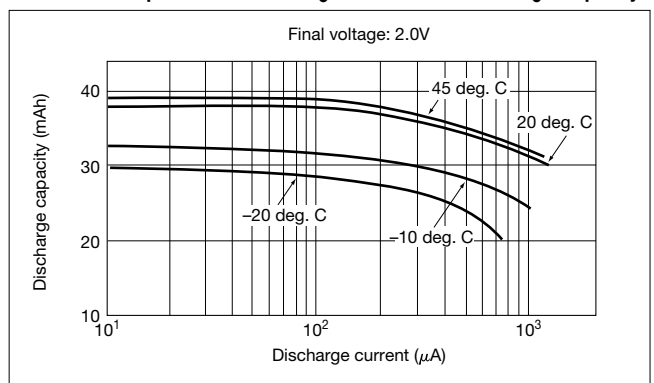
### Temperature Characteristics



### Pulse Discharge Characteristics

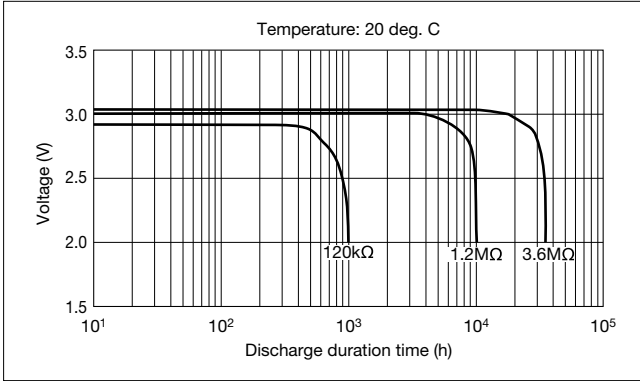


### Relationship between Discharge Current and Discharge Capacity

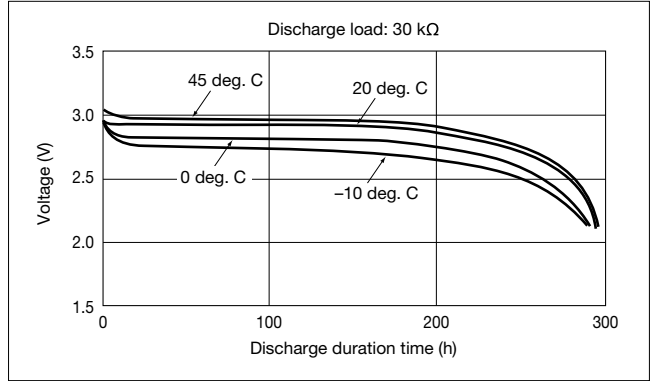


**CR1216** (25mAh)

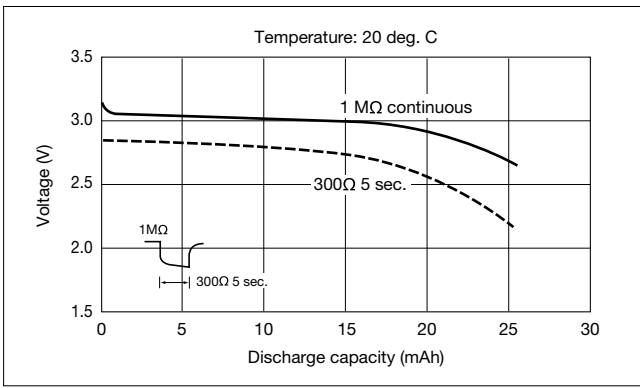
**Discharge Characteristics**



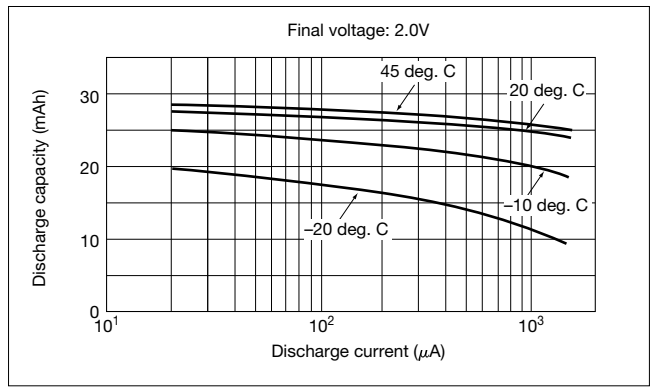
**Temperature Characteristics**



**Pulse Discharge Characteristics**

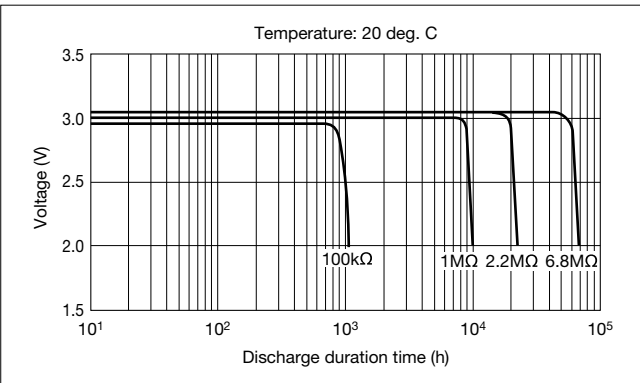


**Relationship between Discharge Current and Discharge Capacity**

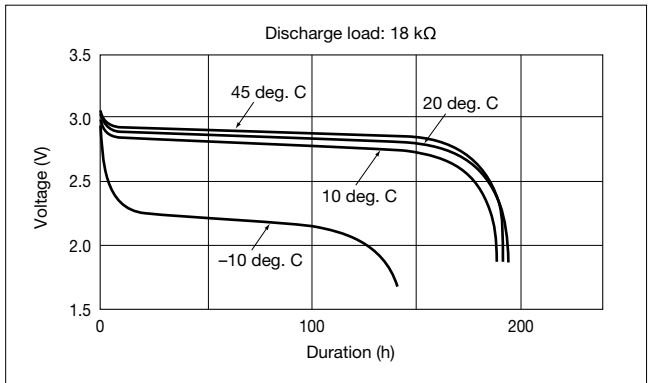


**CR1025** (30mAh)

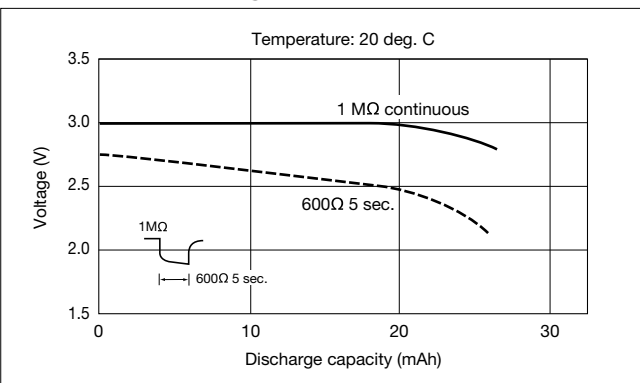
**Discharge Characteristics**



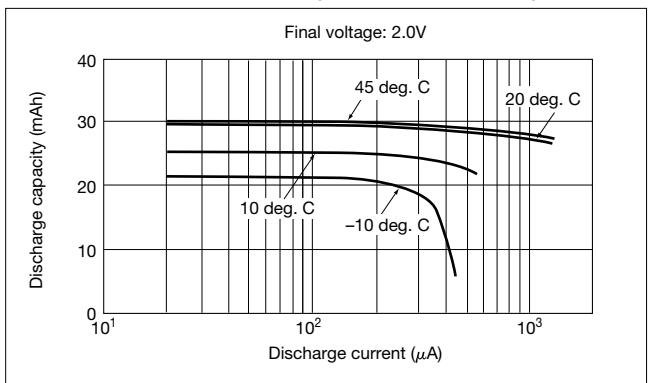
**Temperature Characteristics**



**Pulse Discharge Characteristics**



**Relationship between Discharge Current and Discharge Capacity**



## External Dimensions (unit : mm)

CR2450 T25S	CR2032 T6	CR2032 T6LES	CR2032 T14
<p>Actual appearance</p>	<p>Insulation sleeve</p>		<p>Actual appearance</p>
CR2032 T15	CR2032 T16	CR2032 T19	CR2032 T23
<p>Insulation sleeve</p>	<p>Insulation sleeve</p>		
CR2032 T25	CR2032 T5	CR2032 T20	CR2032 T33
<p>Actual appearance</p>	<p>Insulation sleeve</p>	<p>Insulation sleeve</p>	

External Dimensions (unit : mm)

CR2032 T7	CR2032 T17	CR2032 T26	CR2032 T34
<p>Insulation sleeve</p>	<p>Insulation sleeve</p>	<p>Actual appearance</p>	<p>Insulation sleeve</p>
<p>Insulation sleeve</p> <p>Adhesive tape</p> <p>Lead wire</p> <p>Housing: DF13-2S-1.25C (Hirose) Contact: DF13-2630SCF (Hirose) Wire: AWG28</p>	<p>Insulation sleeve</p> <p>Adhesive tape</p> <p>Lead wire</p> <p>Housing: DF13-2S-1.25C (Hirose) Contact: DF13-2630SCF (Hirose) Wire: AWG28</p>	<p>Insulation sleeve</p> <p>Adhesive tape</p> <p>Lead wire</p> <p>Housing: DF13-2S-1.25C (Hirose) Contact: DF13-2630SCF (Hirose) Wire: AWG28</p>	<p>Insulation sleeve</p> <p>Lead wire</p> <p>Housing: DF3-4S-2C (Hirose) Contact: DF3-2428SCF (Hirose) Wire: AWG26</p>
<p>Insulation sleeve</p> <p>Adhesive tape</p> <p>Lead wire</p> <p>Housing: DF13-2S-1.25C (Hirose) Contact: DF13-2630SCF (Hirose) Wire: AWG28</p>		<p>Insulation sleeve</p>	

- : Tin plating
- : Horizontal & Through hole Type
- : Horizontal & Surface mounting Type
- : Vertical & Through hole Type
- : Wire connector Type

## Overview

Maxell's original sealing technology and highly heat-resistant material expands operating temperature range remarkably, making the batteries supremely suitable for automobile applications — for powering TPMS (Tire Pressure Monitoring System) sensors, for example.

## Products

Model	CR2450HR	CR2450HR-Ex
Nominal Voltage (V)	3	3
Nominal Capacity (mAh)**	550	525
Nominal Discharge Current (mA)	0.2	0.2
Operating Temperature Range (deg. C)	-40 to +125	-40 to +125 (max.150)
Acceleration Resistance	Max. 2000G***	
Dimensions*	Diameter (mm)	24.5
	Height (mm)	5.0
Weight (g)*	6.8	

\* Dimensions and weight are for the battery itself, but may vary depending on terminal specifications and other factors.

\*\* Nominal capacity indicates duration until the voltage drops down to 2.0V when discharged at a nominal discharge current at 20 deg. C.

\*\*\* Equivalent to acceleration when driving at 300km/h, when attached to a 17-inch wheel

• Data and dimensions are just reference values. For further details, please contact your nearest Maxell dealer or distributor.

## Features

■ **Wide operating temperature range: -40 deg. C to +125 deg. C**  
CR2450HR-Ex batteries can even be used at temperatures up to 150 deg. C, depending on other conditions\*.

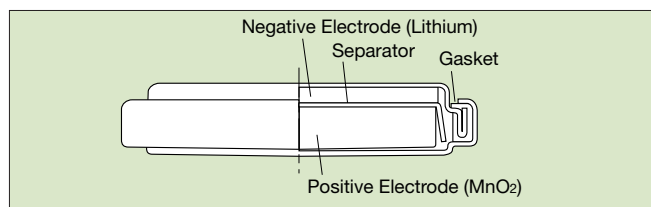
■ **Superior leak-resistant characteristics even under high temperature and acceleration.**

■ **Can be used even under 2000G, which is equivalent to driving at 300km/h.**

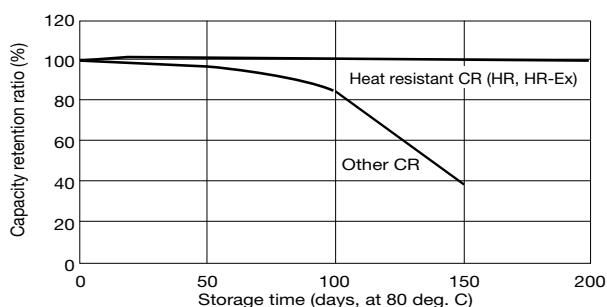
■ **Electric characteristics are maintained after long periods of exposure to high temperature and humidity.**

\*When using CR2450HR and/or CR2450HR-Ex at temperatures exceeding 85 deg. C, please consult Maxell in advance for conditions of use.

## Construction

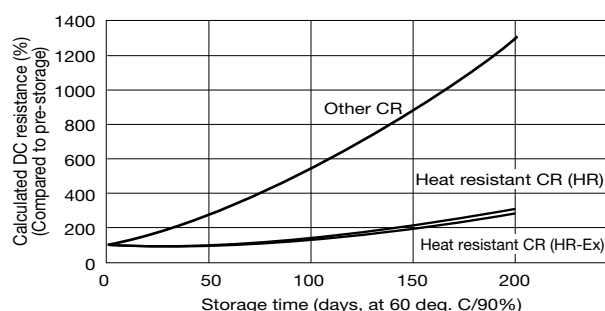


**Fig. 1 Storage Characteristics under High Temperatures**



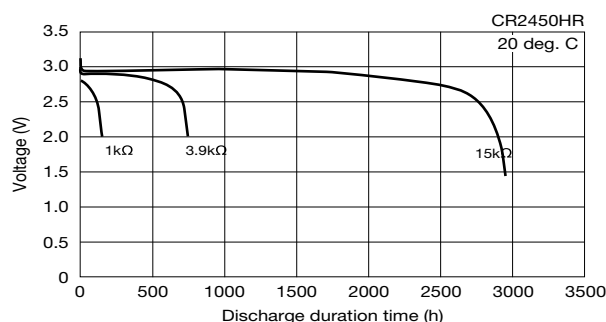
Very little deterioration in capacity due to high storage temperature of 80 deg. C, compared to other CR batteries.

**Fig. 2 Storage Characteristics under High Temperature/Humidity**

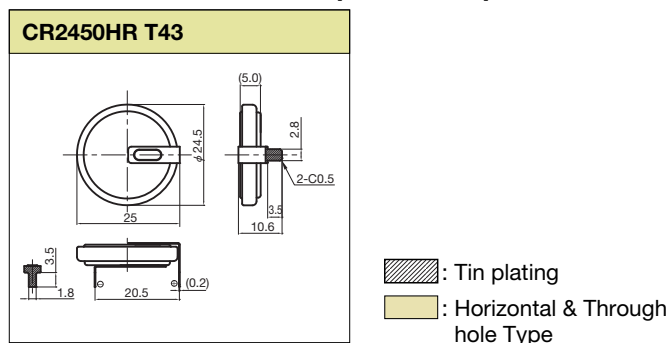


Very little deterioration in internal resistance due to high humidity (60 deg. C/90%RH), compared to other CR batteries.

**Fig. 3 High Rate Discharge Characteristics**



## External Dimensions (unit : mm)

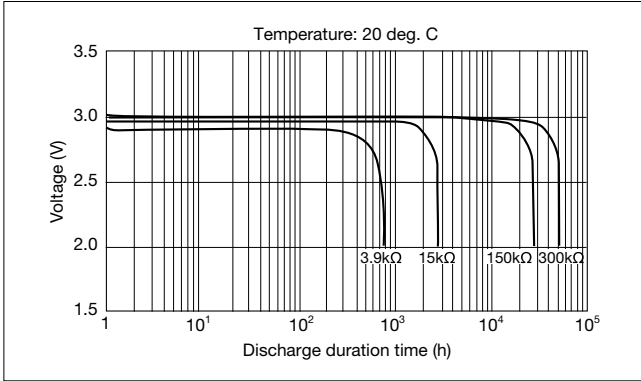


## Applications

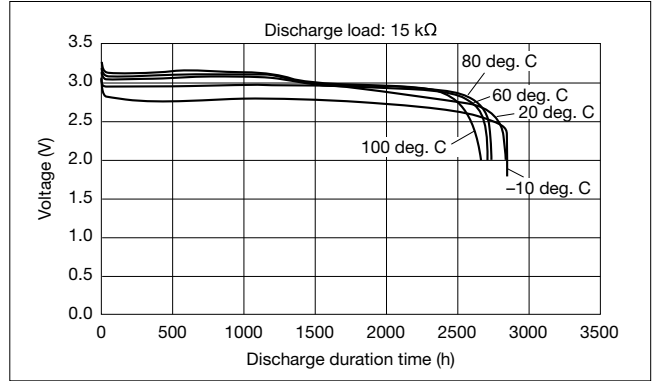
- TPMS (Tire-Pressure Monitoring System)
- ETC (Electronic Toll Collection System)
- Set-Top Boxes
- OA Machines (Fax, Copiers, Printers)
- Notebook PCs
- Desktop PCs
- Medical Instruments, Cash Registers
- FA Instruments (Measuring Instruments, Onboard Microcomputers, Sensors)
- Electronic Meters (Water, Gas, Electricity)

**CR2450HR** (550mAh)

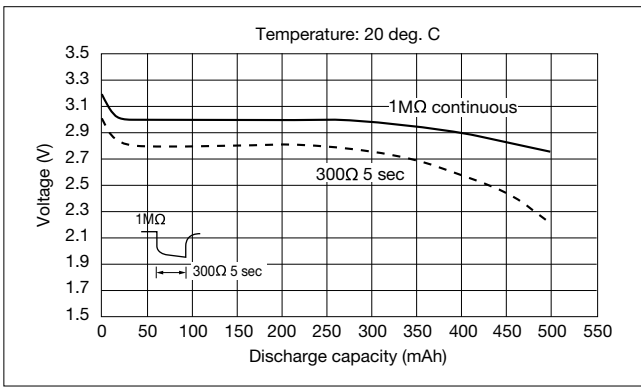
**Discharge Characteristics**



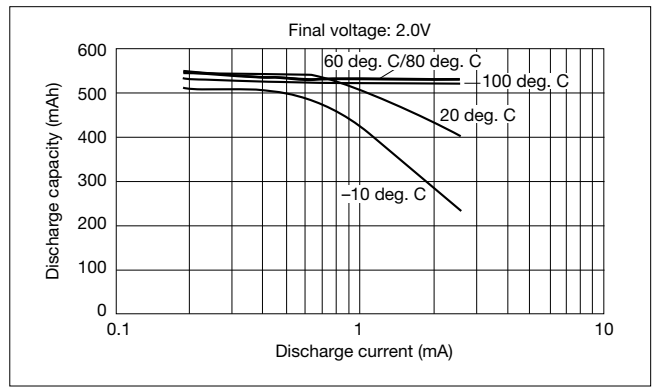
**Temperature Characteristics**



**Pulse Discharge Characteristics**

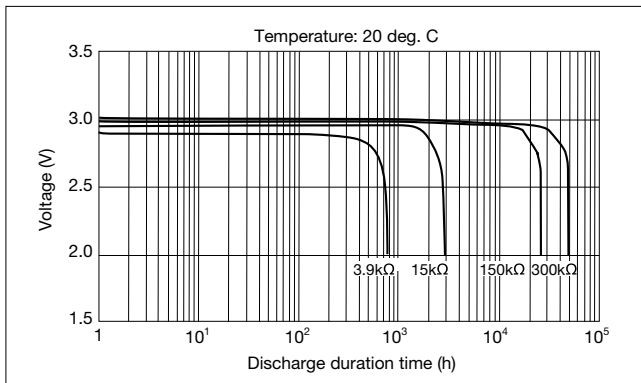


**Relationship between Discharge Current and Discharge Capacity**

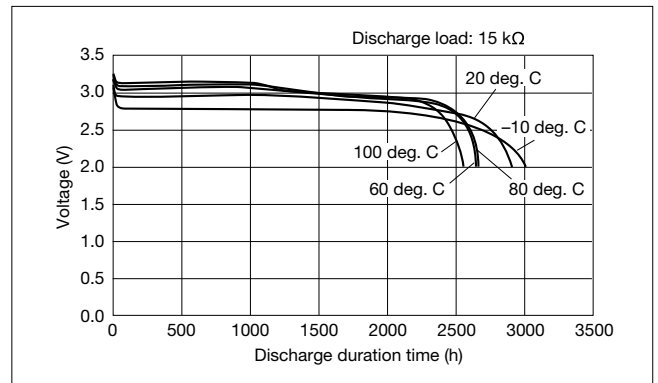


**CR2450HR-Ex** (525mAh)

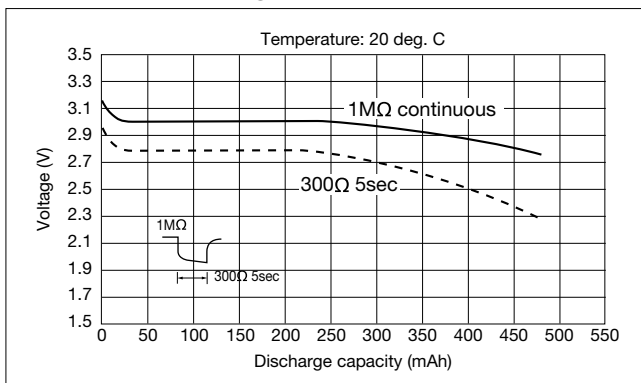
**Discharge Characteristics**



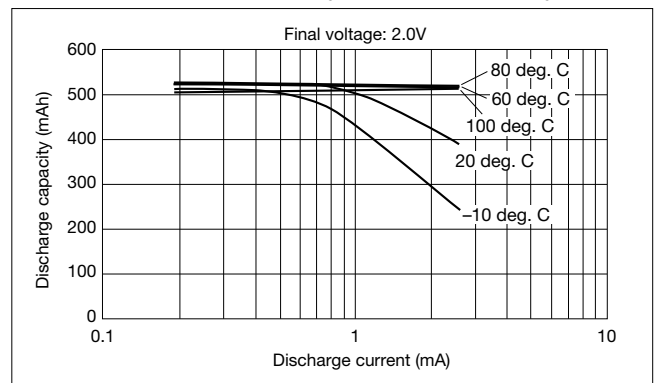
**Temperature Characteristics**



**Pulse Discharge Characteristics**



**Relationship between Discharge Current and Discharge Capacity**



## Overview

The cylindrical lithium manganese dioxide battery (CR battery) features high capacity and excellent load characteristics due to Maxell's unique winding method and improved electrical-conductivity structures. Because of its high-reliability, this battery is ideal for industrial use in, for example, security equipment and the power source of electronic meters.

## Products

Model	CR17450	CR17335
Nominal Voltage (V)	3	3
Nominal Capacity (mAh)**	2600	1750
Nominal Discharge Current (mA)	5	5
Operating Temperature Range (deg. C)	-40 to +85	-40 to +85
Dimensions* Diameter (mm) X Height (mm)	17 X 45	17 X 33.5
Weight (g)*	22	16

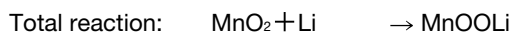
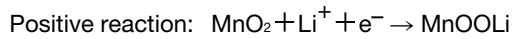
\* Dimensions and weight are for the battery itself, but may vary depending on terminal specifications and other factors.

\*\* Nominal capacity indicates duration until the voltage drops down to 2.0V when discharged at a nominal discharge current at 20 deg. C.

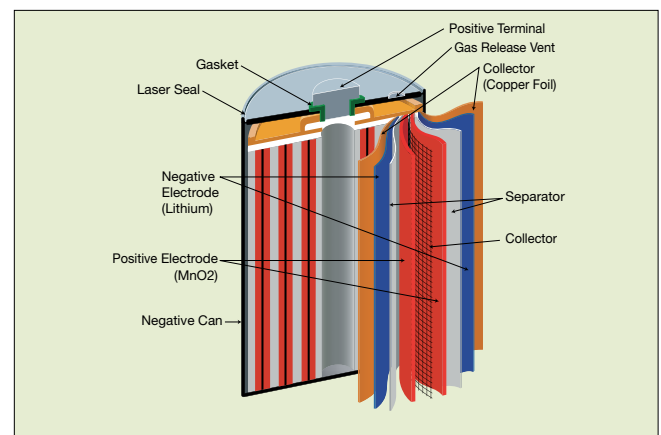
## Principle and Reactions

The cylindrical lithium manganese dioxide battery uses manganese dioxide (MnO<sub>2</sub>) as its positive active material, and lithium (Li) as its negative active material.

### Battery Reactions



## Construction



## Features

### High capacity batteries

Maxell's unique winding method and effective utilization of positive and negative electrodes realize high capacity.

### Low self-discharge rate and long battery life

A laser seal structure ensures air tightness. Minimized electrode surface areas reduce the self-discharge rate.

### Superior storage characteristics

The optimization of positive materials and employment of a high-reliability sealing structure stabilize pulse discharge characteristics over a wide usable temperature range after long-time storage or discharge.

## Applications

- Security Devices
- Home Fire/Smoke Alarms
- Electronic Meters (Water, Gas, Electricity)
- Memory Backup Power

## External Dimensions (unit : mm)

CR17450 VO-T3	CR17450 WK 41	CR17335 VO-T3	CR17335 WK 11
	<p>Housing : PHR-2(JST) Contact : SPH-002T-P0.5S(JST) Lead Wire : AWG26</p>		<p>Housing : PHR-2(JST) Contact : SPH-002T-P0.5S(JST) Lead Wire : AWG26</p>

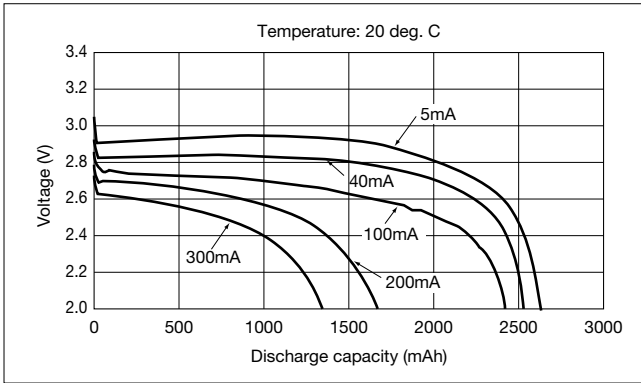
: Tin plating

: Horizontal & Through hole Type

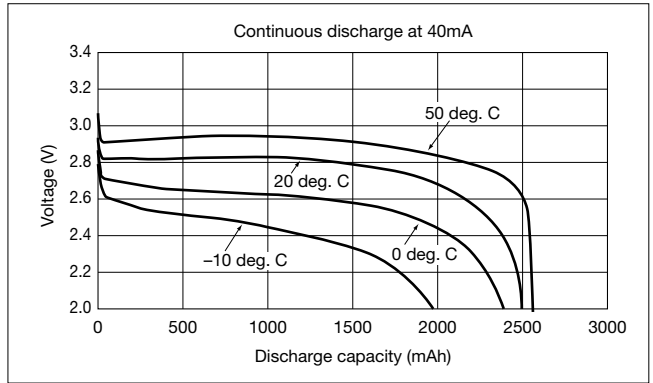
: Wire connector Type

**CR17450** (2600mAh)

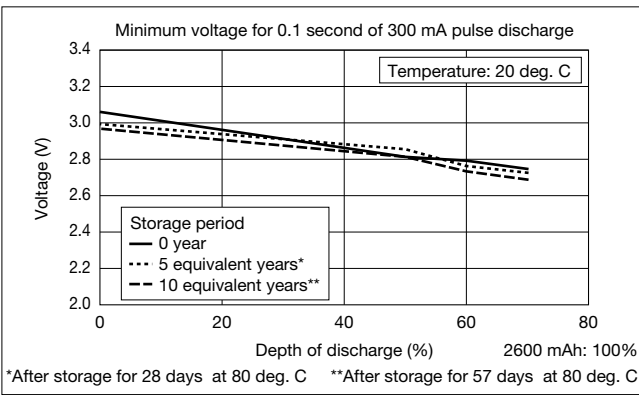
**Discharge Characteristics**



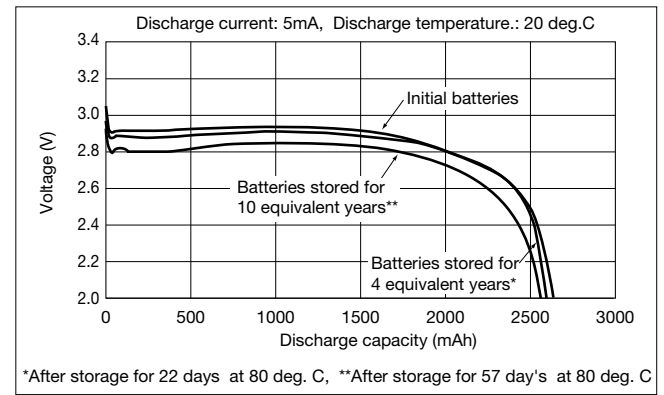
**Temperature Characteristics**



**Pulse Discharge Characteristics**

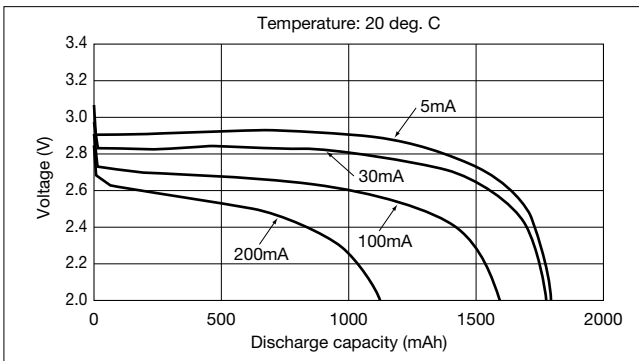


**Storage Characteristics**

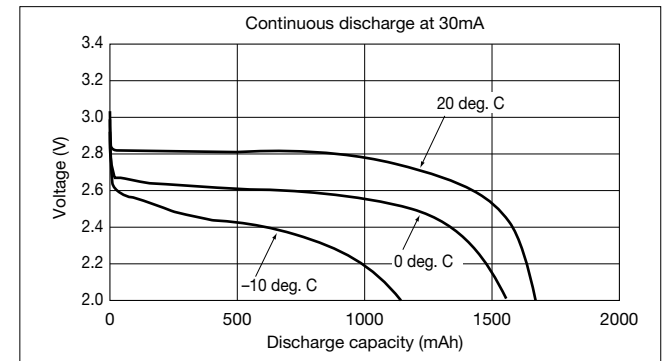


**CR17335** (1750mAh)

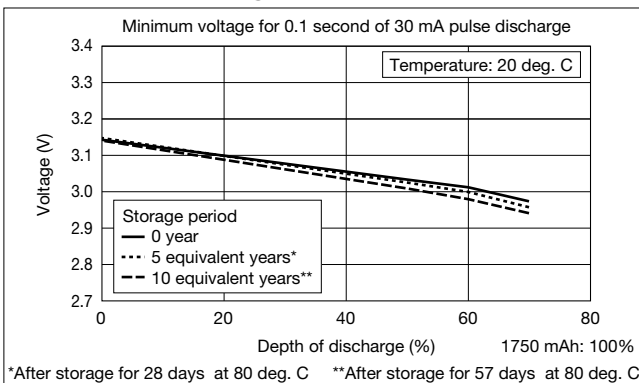
**Discharge Characteristics**



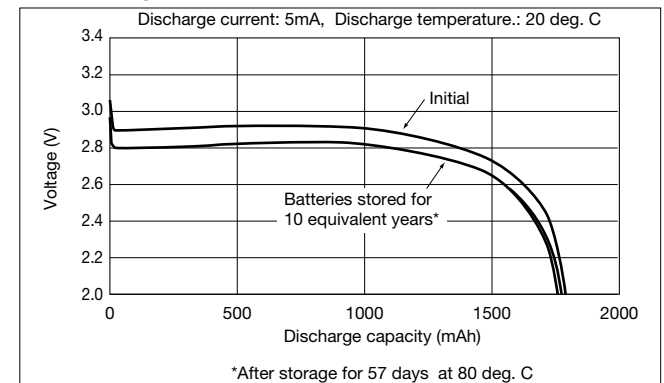
**Temperature Characteristics**



**Pulse Discharge Characteristics**



**Storage Characteristics**







**Hitachi Maxell, Ltd.**  
2-18-2, Iidabashi,  
Chiyoda-ku, Tokyo  
102-8521 Japan  
Tel: (+81) 3-3515-8249  
Fax: (+81) 3-3515-8305

Visit our website at: [www.maxell.com](http://www.maxell.com)

## NORTH AMERICA / SOUTH AMERICA

### Maxell Corporation of America

**Main Office:**  
22-08, Route 208 Fair Lawn, NJ  
07410, U.S.A.  
Tel: (+1) 201-794-5900  
Fax: (+1) 201-796-8790

**Canada Branch:**  
50 Locke Street, Unit #2, Concord,  
Ontario L4K 5R4, Canada  
Tel: (+1) 905-669-8107  
Fax: (+1) 905-669-8108  
E-mail: [support@maxellcanada.com](mailto:support@maxellcanada.com)

### Maxell Latin America

Plaza Btresh - Calle 50, Panama City,  
Panama  
Tel: (+507) 269-6737  
Fax: (+507) 263-4413  
E-mail: [maxell@ciabtresh.com](mailto:maxell@ciabtresh.com)

## EUROPE

### Maxell Europe Ltd.

**European Headquarters:**  
Multimedia House, High Street,  
Rickmansworth, Hertfordshire,  
WD3 1HR, United Kingdom  
Tel: (+44) 1923 33 1000  
Fax: (+44) 1923 33 1010  
E-mail: [hq@maxell.eu.com](mailto:hq@maxell.eu.com)

**UK Sales Office:**  
Multimedia House, High Street,  
Rickmansworth, Hertfordshire,  
WD3 1HR, United Kingdom  
Tel: (+44) 1923 49 4400  
Fax: (+44) 1923 49 4410  
E-mail: [sales@maxell.eu.com](mailto:sales@maxell.eu.com)

### Maxell Deutschland GmbH

Mollsfeld 2, 40670 Meerbusch,  
Germany  
Tel: (+49) 2159-913-0  
Fax: (+49) 2159-913-150  
E-mail: [mdg@maxell.eu.com](mailto:mdg@maxell.eu.com)

### Maxell (France) S.A.

BP 97091 Saint Ouen L'Aumone,  
95 052 Cergy-Pontoise Cedex, France  
Tel: (+33) 1 34 24 88 11  
Fax: (+33) 1 30 73 56 77  
E-mail: [mfr@maxell.fr](mailto:mfr@maxell.fr)

### Maxell Italia S.p.A.

Via Dante 2, 21100 Varese, Italy  
Tel: (+39) 0332-240-934  
Fax: (+39) 0332-240-950  
E-mail: [info@maxell-italia.it](mailto:info@maxell-italia.it)

### Maxell Hungary Kft.

H-1097 Budapest, Mariassy utca 7,  
Hungary  
Tel: (+36) 1 464 3800  
Fax: (+36) 1 464 3801  
E-mail: [mhu@maxell.eu.com](mailto:mhu@maxell.eu.com)

## ASIA

### Maxell Asia, Ltd.

**Main Office:**  
506, World Commerce Centre,  
Harbour City, Phase 1,  
Canton Road, Kowloon,  
Hong Kong  
Tel: (+852) 2730 9243  
Fax: (+852) 2735 6250  
E-mail: [maxell@maxell.com.hk](mailto:maxell@maxell.com.hk)

**Vietnam Office:**  
Suite 15, Mezzanine Floor,  
Sun Wah Tower, 115 Nguyen Hue  
Boulevard, District 1,  
Ho Chi Minh City, Vietnam  
Tel: (+84) 8-821-9183  
Fax: (+84) 8-821-9181  
E-mail: [maxellvn@saigonnet.vn](mailto:maxellvn@saigonnet.vn)

### Maxell (Shanghai) Trading Co., Ltd.

**Main Office:**  
PLAZA 336, Room No.1801, 18th Floor,  
No.336, Xi Zang Middle Road, Huang Pu  
District, Shanghai 200001, China  
Tel: (+86) 21-3330-3377  
Fax: (+86) 21-3330-4001  
E-mail: [maxell@maxell.net.cn](mailto:maxell@maxell.net.cn)

**Beijing Office**  
Room 905, C Wantong Tower, No.6  
Chaowai Road, Chaoyang District 100020,  
Beijing, China  
Tel: (+86) 10-5907-0016  
Fax: (+86) 10-5907-0017  
E-mail: [maxellbj@public.bta.net.cn](mailto:maxellbj@public.bta.net.cn)

### Maxell Taiwan, Ltd.

14F, No.111, Sung Chiang Road,  
Taipei, Taiwan  
Tel: (+886) 2-2516-5553  
Fax: (+886) 2-2516-4804  
E-mail: [maxell@maxell.com.tw](mailto:maxell@maxell.com.tw)

### Maxell Asia (Singapore) Pte. Ltd.

**Main Office:**  
10 Anson Road, #25-06,  
International Plaza, Singapore 079903  
Tel: (+65) 6220-9291  
Fax: (+65) 6220-6070  
E-mail: [sales@maxell.com.sg](mailto:sales@maxell.com.sg)

**Chennai Office:**  
DBS Office Business Center, 31A,  
Cathedral Garden Road, Near  
Palmgrove Hotel, Chennai-600 034,  
Tamil Nadu, India  
Tel: (+91) 44-5264-9495  
Fax: (+91) 44-5264-9495  
E-mail: [maxellchennai@touchtelindia.net](mailto:maxellchennai@touchtelindia.net)